

D&D Motor Systems, Inc.

Programmable

Regen Controller

Manual & Schematics

BE ADVISED, D&D Motor Systems, Inc. does not design and manufacture controllers. We provide them as an extension to our existing motor product line so that our customers may enjoy more of a one stop shopping environment. If we cannot handle any of your basic technical questions, we will refer you to our off-site technical service customer representatives.

Table of Contents

A. Separately Excited Controller Information	
1. "Regen" Controller Overview.....	2
2. Controller Installation.....	3
3. Main Fuse.....	4
4. Troubleshooting.....	4
5. Programming.....	5
B. General Controller Information	
1. Limited Warranty.....	6
2. Return Procedure.....	6
Appendix A – Programming the Controller out of the Vehicle	
Appendix B – Fuse Installation Guide	
Appendix C – Contactor, Resistor Coil and Diode Installation	
Appendix D – Vehicle Wiring Schematics	
- EZ-GO: DCS & PDS Vehicles	
- Club Car IQ System	
- Club Car PDPlus Vehicles	
- Yamaha Regen G-19 Vehicles	
Appendix E – Controller Specifications	

A) **Separately Excited Controller Information**

1. **Regenerative Braking (“Regen”) Controller Product Overview**

This motor controller is designed to work with various golf cars depending on configuration and adapter harness used. See chart below to assure correct configuration of the controller for your vehicle.

EZ-GO				
Model	D&D Controller	Field Map #	Adapter	Throttle Type
DCS	300/400/600-DCS	3	None	ITS
PDS	300/400/600-PDS	4	PDS	ITS
Club Car				
IQ	300/400/600-IQ	6	IQ	5K-0, 3 Wire
PD Plus	300/400/600-PDPlus	8	PD Plus	5K-0, 3 Wire
Yamaha				
G-19	300/400/600-G19	8	G-19	0-5K

The 300 Regen controller is intended to be a bolt in replacement for the standard controller found in EZ-GO Regen cars. The 400 Regen has the same foot print as the 300 Regen but offers increased torque and acceleration. The 600 Regen offers even more torque and is for heavier loads like larger tires and towing. The 600 Regen may require mounting modifications since it has a *longer* footprint. All three may be used in all vehicles above. The adapter kits allow the existing wiring to simply plug in.

Note: *The Tach speed limiting is disabled on PDS and G-19 cars when using our controller. The speed sensor attached to the end of the motor is NOT used and should be secured to the motor frame.*

Stock motors may not be able to handle sustained high current operation the 600 Amp Regen is capable of delivering. Overheating of motor can occur if vehicle is overloaded.

2. Installation:

The installation instructions assume that the installer is a qualified golf car technician and is fully aware of the hazards and safety precautions required when working with high current battery powered vehicles. Wear safety glasses and elevate the wheels prior to testing any electric vehicle. Place jack stands under rear axle. Disconnect all wires from the battery pack + terminal.

EZ-GO

Remove black cover from existing controller. Observe wiring orientation prior to disassembly. Remove relay bracket. Mount relay on top of D&D controller using the stock bolts to secure the relay to the plastic inserts. Align notches in controller mounting flange with relay bracket holes in heatsink and secure with 2 bolts. The black cover can be re-installed over the 300 Regen and 400 Regen controllers but not over the 600 Regen controller. The PDS car uses a PDS adapter cable that plugs between the stock connectors and the controller.

Club Car & Yamaha

See the installation instructions provided with the controller adapter kits for these golf cars.

Wiring conversion from Curtis to D&D Regen controller:

<u>Curtis DCS/PDS</u>	<u>D&D Regen</u>	<u>Function</u>
A1	M-	Controller output to motor A1
B-	B-	Battery negative terminal
A2/B+	B+	Battery positive from solenoid & motor A2
F1	F1	Motor F1
F2	F2	Motor F2
10 pin	10 pin	Control wiring

Observe orientation of 10 pin connector. Pin 8 is removed to indicate connector polarity.

Some cars may require replacement of the wire going from B+ on the controller to the output side of the solenoid as it is too short. Use 4-6AWG wire to replace if needed. Tuck wires sharply down the back of the controller to allow stock EZ-GO cover to be reinstalled.

Make sure a Diode (1A, 100V) is installed across the Solenoid/Contactor coil and other relays that may be installed for extra lights or accessories. The Cathode or Banded end should face the Positive terminal. These diodes are required to prevent the speed sensor from producing erroneous signals.

3. Fusing:

A fuse is required in the battery circuit. Place a Buss ANN-250, 250A fuse for 300-400 amp controllers or a Buss ANN-400, 400A fuse for the 600 amp controller, in series with one of the battery interconnects, or in line between the controllers B- bus bar and the B- terminal of the battery. D&D part numbers are FUS110-011 for 250A fuse and FUS110-012 for 400A fuse.

4. Troubleshooting:

At power up the controller will blink the LED green a number of times, which identifies the throttle configuration stored in the controller. If no error is detected, the LED will stay solid green after the throttle pattern is displayed. Verify the throttle configured in the controller matches the throttle in the car. If the controller detects an error, a red pattern will blink right after the green throttle pattern. There is a ½ second delay between blinks. The error codes will repeat after a 1 second delay until the error is cleared.

<u>Green Blinks</u>	<u>Throttle Type</u>	<u>Car Type</u>
1	0-5K	Yamaha, Elec-Trak, Fairplay
4	ITS	EZ-GO
7	5K-0 3wire	Club Car

Red Blinks = Error Code

- 1 red** = Throttle sensor over range. Open throttle wires or wrong configuration for throttle used.
- 2 red** = Under temperature. Controller shuts down at temps below -25C.
- 3 red** = HPD. Throttle has not returned to zero during this power up sequence. Is throttle stuck?
- 4 red** = Over temperature. Controller shuts down at temps greater than 95C.
- 5 red** = Open field circuit. Check field connections and motor's field resistance.
- 6 red** = Battery undervoltage shutdown. Check pack voltage and undervoltage slider.
- 7 red** = Battery overvoltage shutdown. Check pack voltage, charger and overvoltage slider.

NOTE: When making voltage measurements, measure at the controller not the battery pack. Open Field (5 red) nuisance alarms will occur when changing direction or cycling the throttle with older revisions of software. The alarms do not effect operation. Contact D&D, if this is a concern, to get software updates.

Solid Green = Controller ready for operation.

Solid yellow = Throttle wide open and controller not in current limit.

Solid RED = Controller in bootload mode. This state only occurs during software upgrades.

5. Programming

This controller may be programmed to change operating characteristics such as throttle response rate, throttle type, top speed and braking force. Go to www.ddmotorsystems.com and download the free software tool WebControllerPRO.exe (see software installation manual). The interface, "WEBControllerPRO", is a utility program which operates on Windows NT/XP operating systems. The program provides a fairly intuitive way to tune and calibrate the motor controllers operating parameters. The controller uses either COM1 through COM7 serial port, RS-232 logic levels, 9600 baud, 8 data bits, 1 stop bit, no parity.

Use a standard DB-9 pin / RS-232 serial interface cable to connect the controller to the PC. If your computer is not provided with a DB-9 pin serial port a USB to RS-232 Serial adapter / converter is available through www.tigerdirect.com and other sources.

If you need the entire programming kit, we do sell them. Please contact us if you need a kit.

Note: the controllers RS-232 serial port is referenced to the B- battery connection. Beware any possible ground loop faults which could damage both the Controller and PC, plus the person doing the work! Disconnect all battery charging sources while programming your Controller.

If programming your controller when it is connected to the vehicle, refer to the wiring schematics. If you want to program the controller while out of the vehicle, refer to the attached sheet: "Appendix B"

B) General Controller Information

1. LIMITED WARRANTY

D&D Motor Systems, Inc. warrants every product it sells to be free from defects in materials or workmanship for a period of 2 years from the date of manufacture. This warranty does not apply to defects due directly or indirectly to misuse, abuse, negligence, accidents, repairs or alterations. We shall in no event be liable for death, injuries to persons or property or for incidental, contingent or consequential damages arising through the use of our products. D&D Motor Systems, Inc. specifically disclaims the implied warranties of merchantability and fitness for a particular purpose, however some areas do not allow limitations on how long an implied warranty lasts, so the preceding exclusion may not apply to you. This is D&D Motor Systems, Inc. sole written warranty, no other warranty is expressed or implied.

In the event you should need warranty repair, Please see the Return Procedure below. D&D Motor Systems reserves the right to repair or replace merchandise at its option. D&D Motor Systems reserves the right to make changes to any of its products or specifications without notice.

2. Return Procedure

Call D&D Motor Systems, Inc. at (315) 701-0635
Fax us at (315) 701-0859

Explain the nature of the problem to our service personnel and we will provide you with return directions. You pay shipping to us, we pay the return shipping to you as long as the warranty is accepted. Package the controller securely in original shipping box if at all possible, we are not responsible for damage in shipping.

APPENDIX A

PART NO.	
----------	--

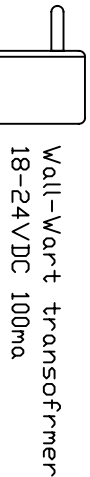

Regen-Pins 5,6,9,10
Series Pin 1



Regen-Pins 5,6,9,10
Series Pin 1



Regen-Pins 5,6,9,10
Series Pin 1



Regen-Pins 5,6,9,10
Series Pin 1

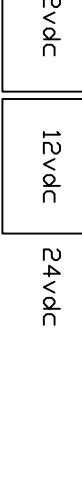

Regen-Pins 5,6,9,10
Series Pin 1

CAUTION: Observe polarity when connecting DC Source

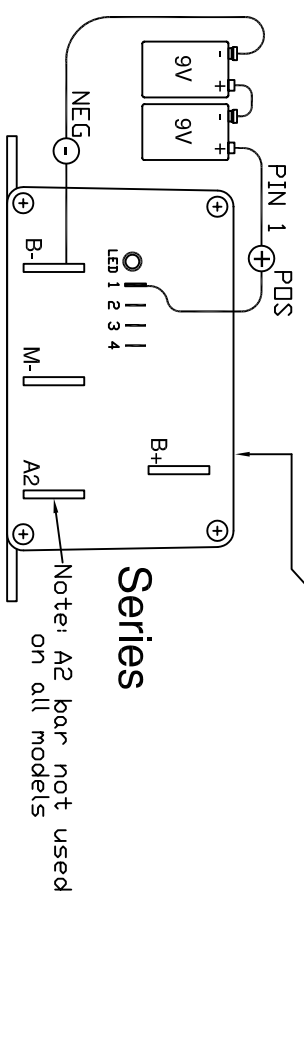
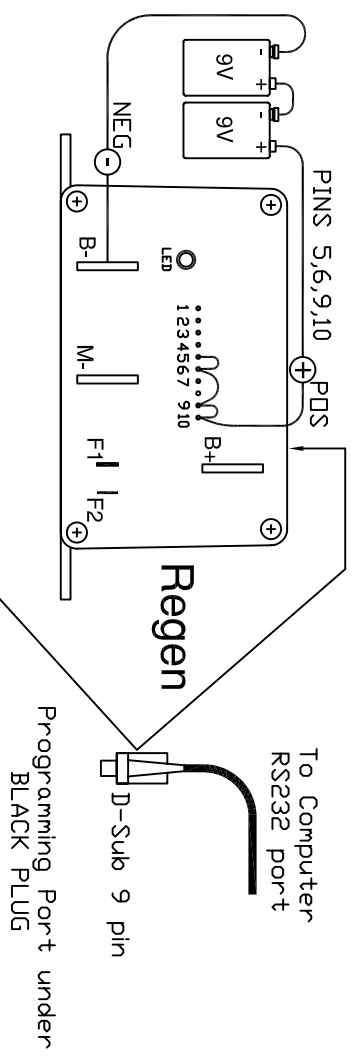

DO NOT EXCEED
CONTROLLER VOLTAGE RATING

>This diagram assumes the controller is programmed out of the vehicle
>See Controller Pro operators manual for more information
>FAILURE TO OBSERVE POLARITY WILL DAMAGE THE CONTROLLER AND VOID THE WARRANTY

DO NOT SCALE DRAWING

PROCEDURE:

1. Connect two 9 volt batteries in series (observe the polarity of the batteries)
2. Connect the PC Computer cable
3. Start Controller Pro Program
4. Program the unit and disconnect the assembly

> When in doubt - CALL D&D Customer Service! <

REVISIONS				DWG SCALE: NTS		TITLE	
REV.	ECO.	DATE	APVD	DRWN	I.Thorne	102406	D&D Motor Systems, Inc.
A	102406	102406	TT	ENGR	D.Crockett	102406	215 Park Ave. Syracuse, NY 13204 PHONE:(315) 701-0635
<p>PROPRIETARY THIS INFORMATION IS PROPRIETARY AND SHALL NOT BE REPRODUCED OR TRANSMITTED IN ANY FORM OR BY ANY MEANS WITHOUT PERMISSION OF D&D</p>							
				SIZE DOCUMENT NO.		REV.	
				A S Doc100-033		A	
<p>FIGURE-033-A-DWG-Controller-Program-Diagram-SHEET 1 of 1</p>							

APPENDIX B

FUSE INSTALLATION GUIDE

We recommend that all motor controller applications have a fuse in the battery circuit. Many vehicles do not have a fuse, follow these guidelines to determine a suitable location. Fuse may be installed anywhere in the battery string, or at either + or - end of the battery pack, where it connects to controller or solenoid.

Controller Rated Current:

400 amps or less
450 amps or more

Recommended Fuse:

ANN250 Bussman or Littelfuse
ANN400



Example 1: On Battery

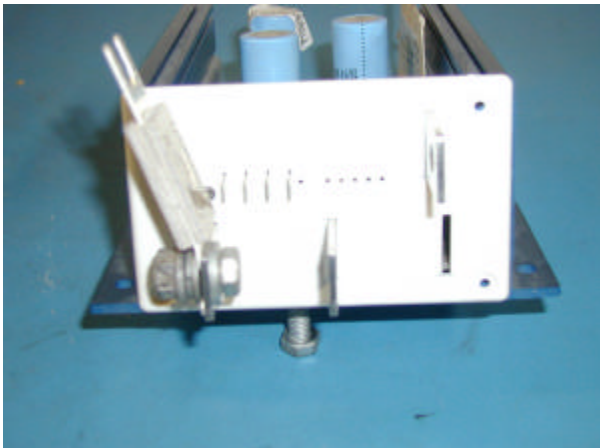

Example 2: On controller B- bar

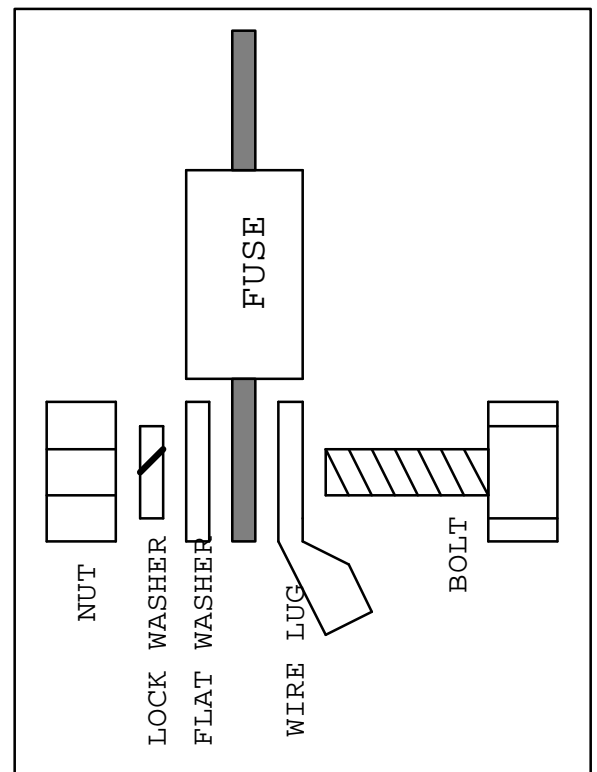

APPENDIX C

Contactor (solenoid), Resistor Coil and Diode Installation Guide



Always wear appropriate eye protection! Place car in tow position before disconnecting the batteries!

1. Begin by placing the car in the tow position! Disconnect both the positive and negative main power connections to the battery pack.
2. Remove all existing power cables. Remove the rear body inspection cover. Disconnect the activation wiring from the motor, controller, solenoid and run/tow switch. Remove the controller and solenoid from the heat sink.
3. At this point identify the parts that are to be installed.
4. Mount the solenoid.
 - a. Mount the 1st solenoid bracket on top of the controller (use your existing ¼ mounting screws). Note the position for the appropriate solenoid in the pictures below. *Mount using hole closest to corner of bracket: Left side of controller for the SW180, Right side of controller for the SW80.*

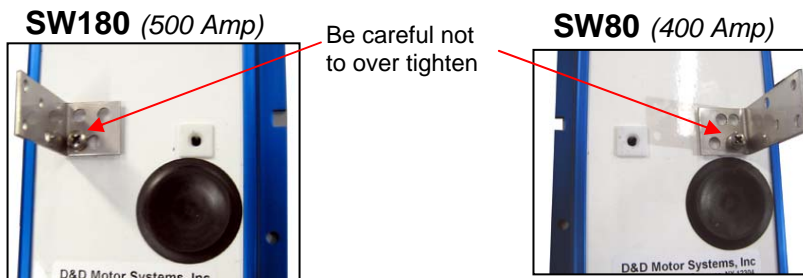

- b. Mount the 2nd bracket to the solenoid. *Mount the bracket to the Right side of the SW180. Mount the bracket to the Left side of the SW80. Uses 2 of the 4 mounting holes. Be sure to use lock washers, without them it will damage the solenoid.*

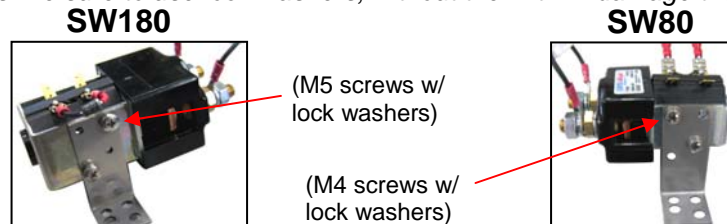

- c. Now mount the solenoid, with bracket attached, to the top of the controller in the remaining hole. At this point only keep screw fairly loose.

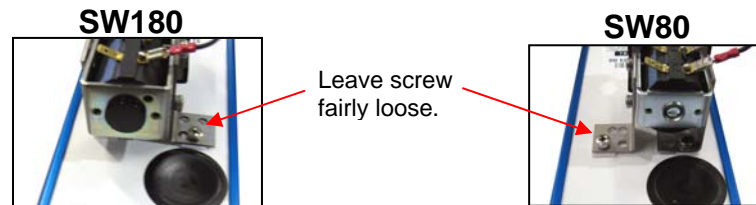

- d. Now line up 2 holes on the bracket with the threaded holes on the solenoid and fasten screws. *Be sure to use lock washers, without them it will damage the solenoid. (see pictures on the next page)*

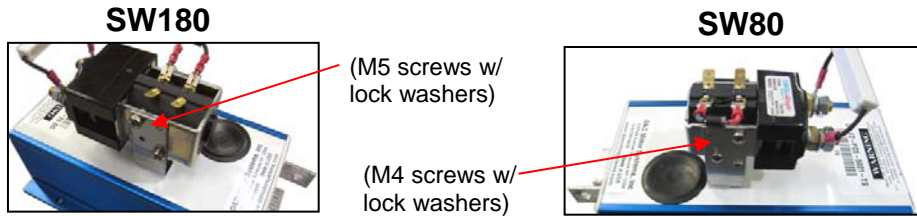

e. Now tighten down the screw from Step 6 above.

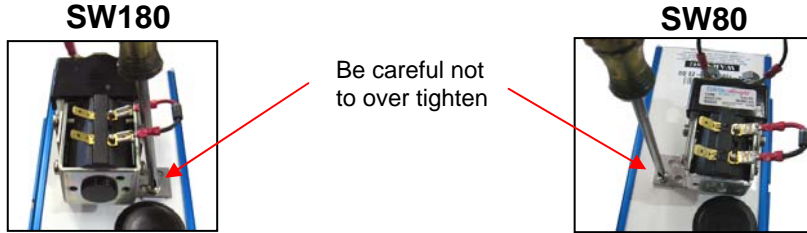

f. Other Solenoids.



200 Amp
Note: For the 200 amp solenoid, mount as illustrated in the picture to the left.

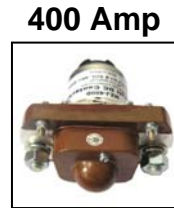

400 Amp
Note: For the 400 amp solenoid depicted to the left, mount in the existing location on the vehicle.

5. Install the resistor across the two large solenoid terminals. Install the diode across the two small solenoid terminals. **Tech Tip:** All connections on the motor, controller and solenoid use connections requiring the double wrench technique. Distorting or damaging connection points are not covered by warranty.

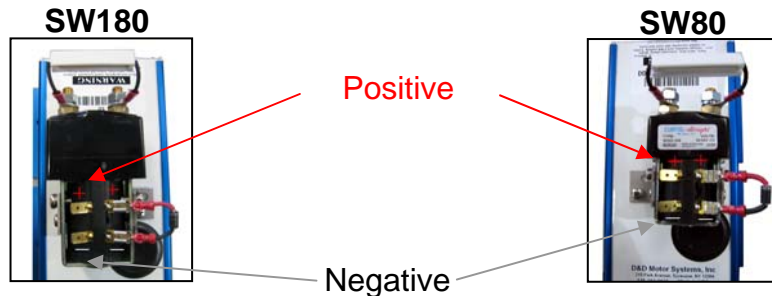

The solenoid has two small terminals for activation. Across these two terminals is a diode. Connections to the diode must be correct! Failure to do so will cause harm to the system and is not covered by warranty.

E-Z-GO: DCS: The Yellow activation wire must connect to the diode red lead (positive). The blue activation wire must connect to the black diode lead (negative). The red accelerator switch wire connects to the red diode lead with the yellow wire.

E-Z-GO: PDS: The Yellow activation wire must connect to the diode red lead (positive). The blue activation wire must connect to the black diode lead (negative).

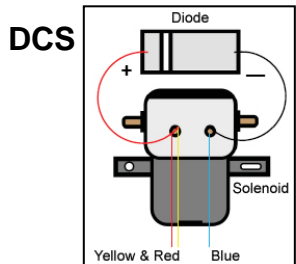

Note: 200 amp Solenoid depicted in this section.

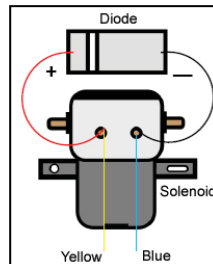

6. Connect all motor and controller connections according to proper wiring diagram.

Regen: EZ-GO-DCS & PDS

FOR SHUNT (SEP-EX) WOUND MOTORS

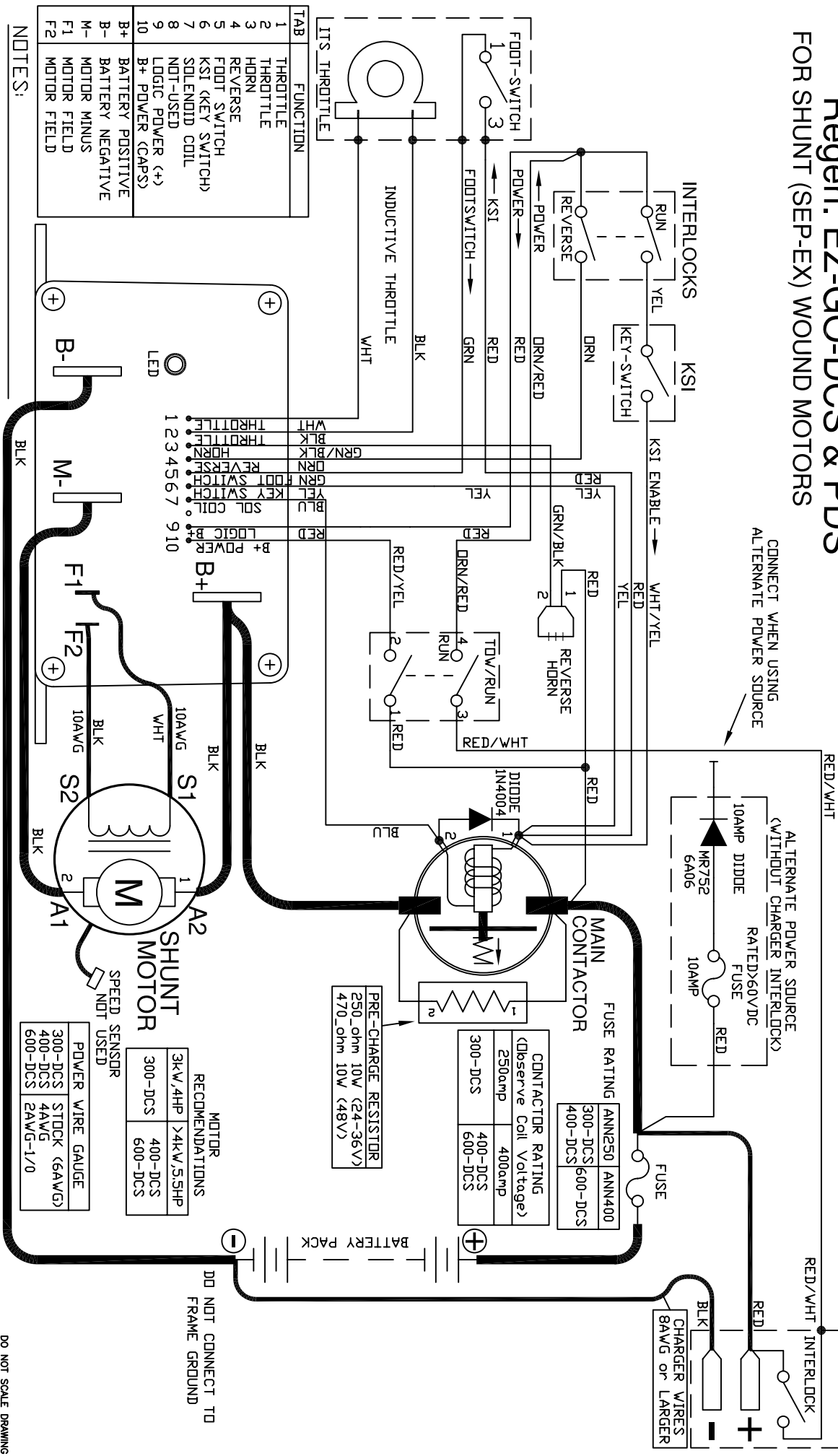

TAB	FUNCTION
1	THROTTLE
2	THROTTLE
3	HORN
4	REVERSE
5	FOOT SWITCH
6	KSI (KEY SWITCH)
7	SOLENOID COIL
8	NOT-USED
9	LOGIC POWER (+)
10	B+ POWER (CAPS)

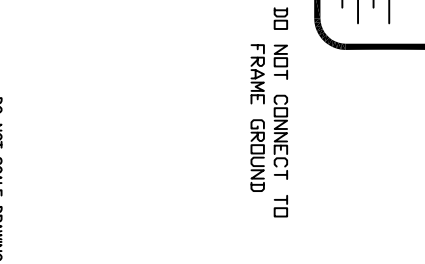
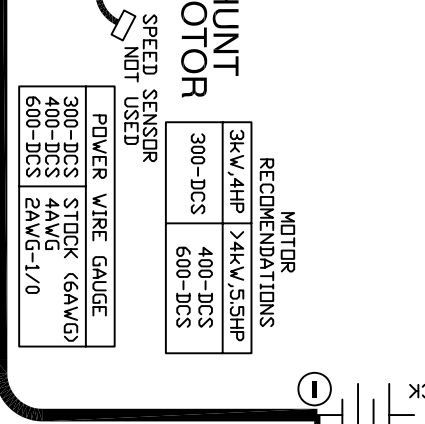
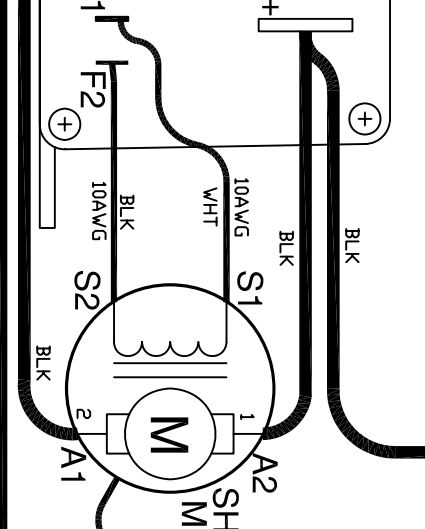
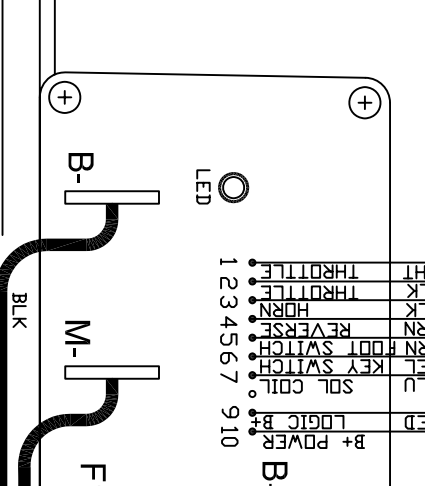

DO NOT SCALE DRAWING

- NOTES:
- * FUSES REQUIRED FOR ALL INSTALLATIONS
 - * DIDDE REQUIRED ACROSS COILS / RELAYS
 - * TOW/RUN SWITCH PREVENTS REGEN WHILE TOWING
 - * ASSUMES FOOTSWITCH IS OPEN WHEN THROTTLE OFF
 - > D&D Motor Systems, Inc. RESERVES THE RIGHT TO CHANGE DOCUMENTATION WITHOUT NOTICE
 - > D&D MAKES NO WARRANTY AS TO THE ACCURACY, SUFFICIENCY, OR SUITABILITY OF ANY TECHNICAL OR OTHER INFORMATION PROVIDED
 - > SEE OPERATORS MANUAL FOR MORE INFORMATION

REVISIONS			DWG SCALE: NTS	
REV.	ECO.	DATE	APVD	DRAWN
A	010407	010407	TT	ENGR D.Crockett

PROPERTY	DATE	BY
REGEN	12/20/06	T.Thorne
SYNCHROUSE	12/20/06	D.Crockett

THIS IS A PROPRIETARY DOCUMENT AND SHALL NOT BE REPRODUCED OR TRANSMITTED IN ANY FORM OR BY ANY MEANS WITHOUT PERMISSION OF D&D

TITLE	D&D Motor Systems, Inc.	215 Park Ave. Syracuse, NY 13204
SIZE	DOCUMENT NO.	PHONE:(315) 701-0655
A	S	Doc100-051
REV.		

Wire Color	J1 Pin #	Signal Name
White	1	Throttle Ground
Yellow	2	Throttle Signal
Lt Blue	5	OBC Disable (charger interlock)
Green	6	Throttle Microswitch
Org/Wht	7	Horn
Brown	8	Forward
Gray	9	Run/Tow
Tan	10	Key Switch
Blu/Wht	12	Contact Drive
Blue	16	Reverse

IQ Adapter Pinout

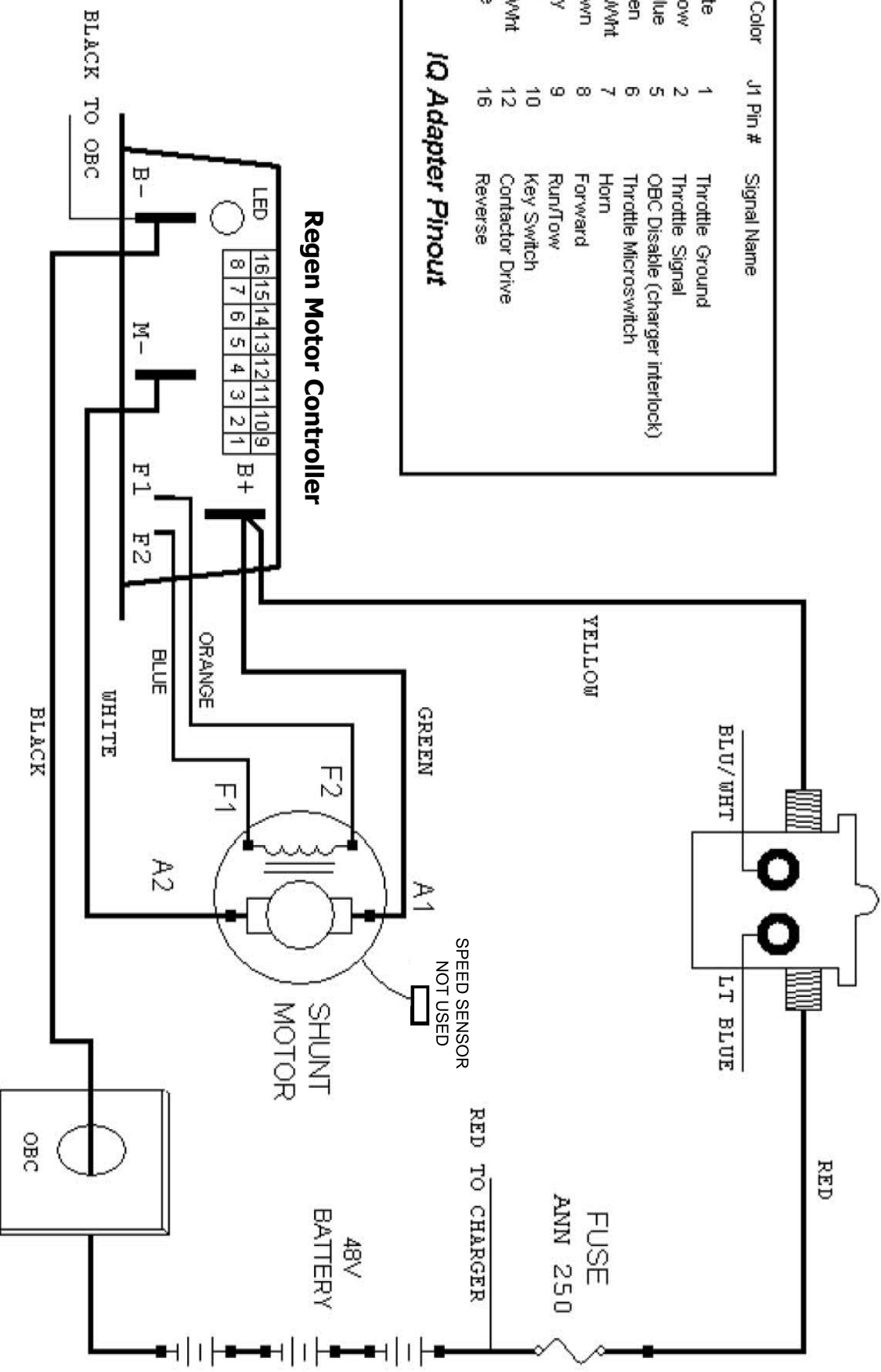

CAUTION: Regen requires IQ adapter and must be configured for use with Club Car IQ vehicles. Refer to vehicle manual for cart wiring not shown. 4 pin connector going to motor speed sensor is not used.

D&D Motor Systems, Inc.
 215 Park Ave.
 Syracuse, NY 13204

Phone: 315-701-0635
 Fax: 315-701-0859
 www.ddmotorsystems.com

Club Car IQ Controller
 with IQ adapter

D&D Motor Systems, Inc.

Club Car PD Plus Adapter installation

The following steps describe the installation of the D&D Motor Systems, Inc. Regen controller in a Club Car golf car. Refer to the Club Car schematic and the pictures supplied with these instructions during installation.

STUDY THE ATTACHED PICTURES BEFORE STARTING THE INSTALLATION !

NOTE: For this installation, the motor speed sensor is NOT used.

Secure the wires so they do not interfere with moving parts.

- 1- Cut white wire in wiring harness leaving enough on both ends to connect with butt connector.
- 2- Splice the 5 ½" white wire from the kit onto the two ends of the white wire that was cut.
- 3- Connect opposite end of 5 ½" wire to J3 on the adaptor.
- 4- Cut Solid blue wire coming from contactor close to the wiring harness.
- 5- Splice together the blue wire from the contactor, the 12" and 33" blue wire from the adaptor kit using the butt connector.
- 6- Feed the other end of the 33" wire under the passenger compartment.
- 7- Plug the other end of the 12" wire onto J2 of the adaptor.
- 8- Cut the blue wire that feeds between the two wire bundles and splice the two ends onto the 33" wire coming from the motor compartment using the butt connector supplied.
- 9- Attach motor's A1 terminal (green wire) to controller's M- bus bar.
- 10- Attach motor's A2 terminal (white wire) to controller's A+ bus bar. On "Powerdrive Plus" model cars the regen solenoid should be removed. It's not used with D&D controllers. Also tape up two wires that control the solenoid.

- 11- Connect controller's F1 lug to motor's F1 terminal with orange cabled supplied in kit. Connect controller's F2 lug to motor's F2 terminal using blue wire from kit.
- 12- Plug black control plug into the controller adaptor.
- 13- Reconnect the batteries.

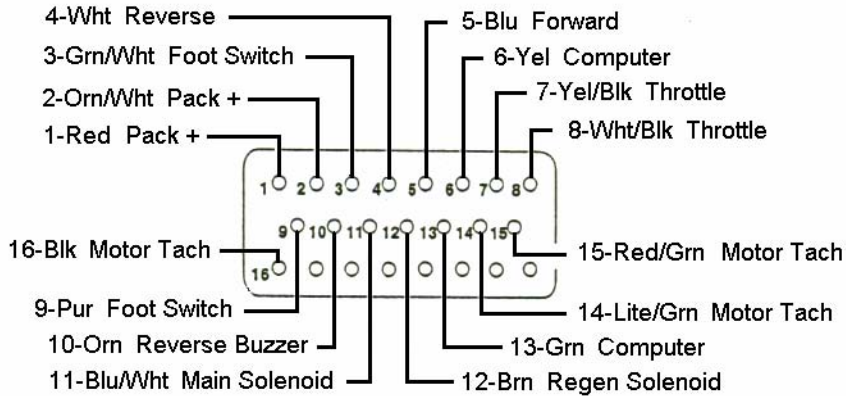

NOTE: If you get a HPD error (three red blinks) make sure the Throttle Micro Switch is being activated BEFORE the throttle signal changes.

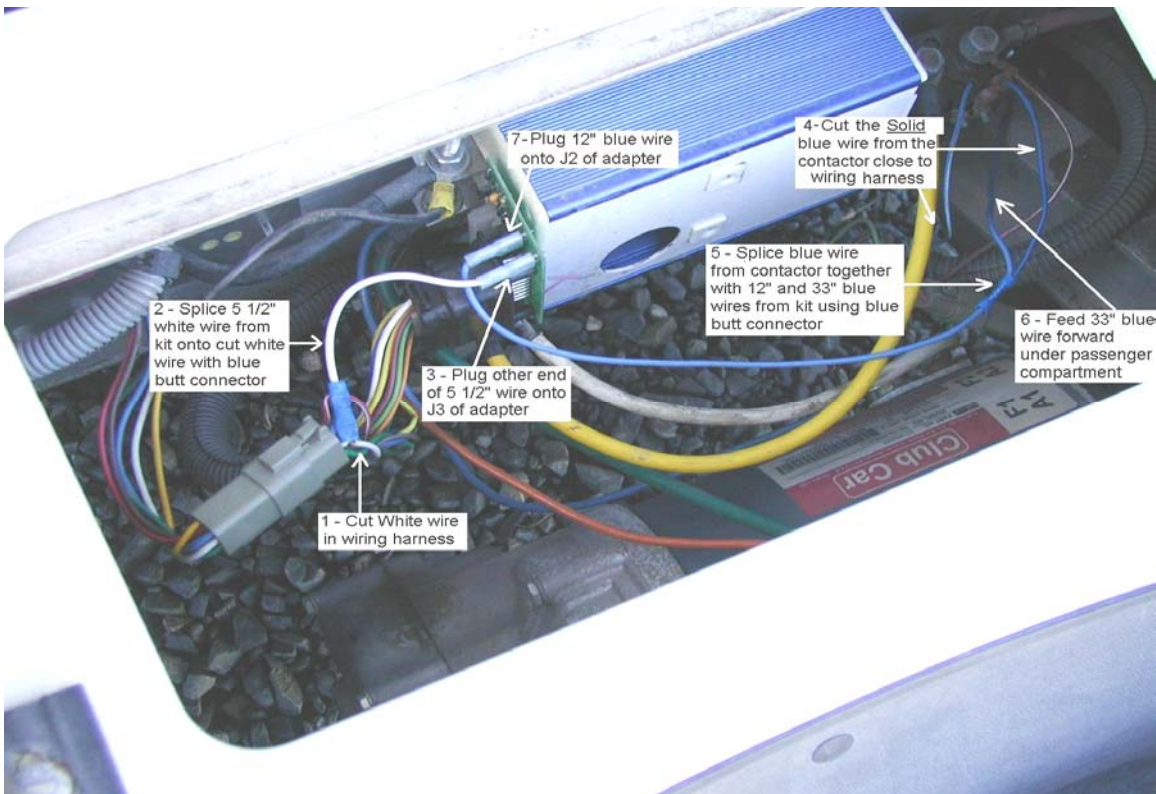

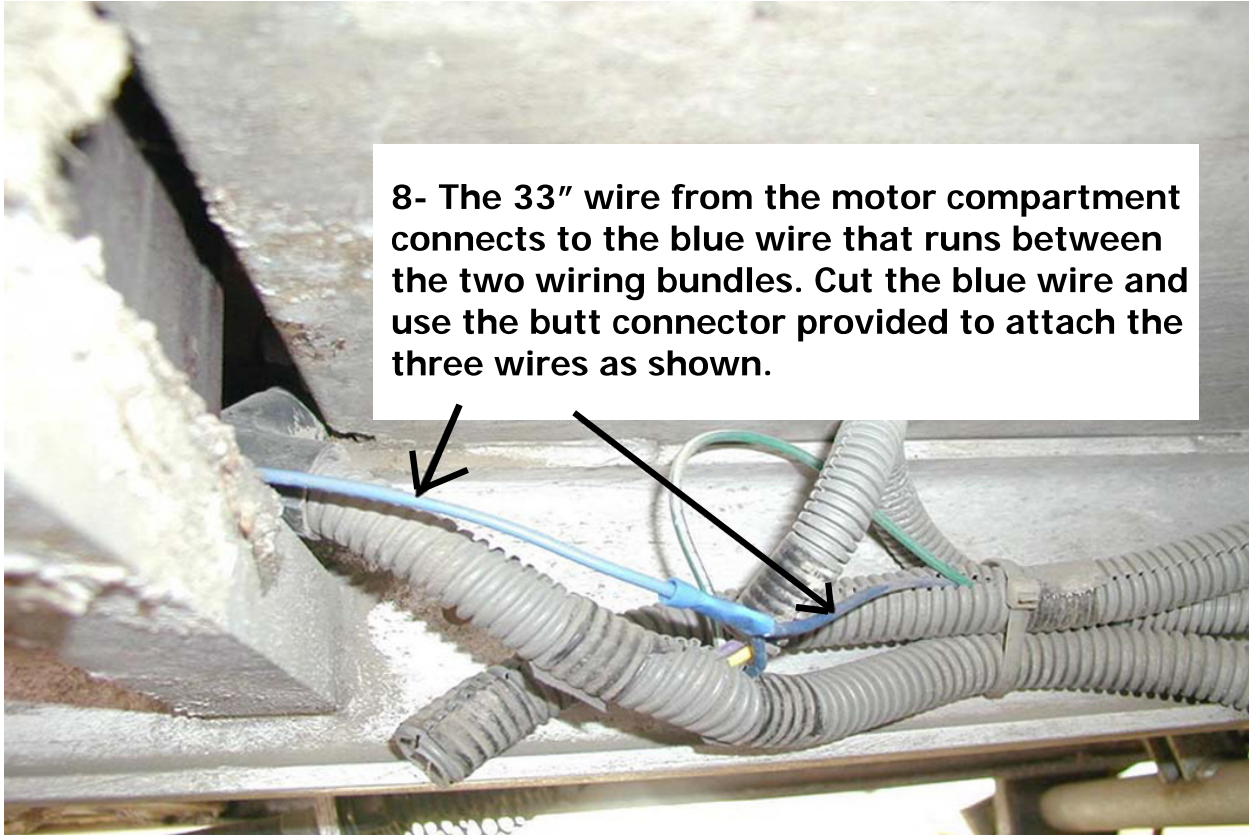

D&D Motor Systems, Inc.

215 Park Avenue

Syracuse, NY 13204

315-701-0635

315-701-0859 Fax

www.ddmotorsystems.com

D&D Motor Systems, Inc.

"Yamaha G-19 Conversion to D&D Regen Controller"

The following steps describe the installation of the D&D Motor Systems, Inc. Regen controller in a Yamaha G-19 golf car. Refer to the Yamaha schematic and the picture supplied with these instructions during installation.

- 1- Remove the two center and the two passenger side batteries from the car.
- 2- Remove the old controller.
- 3- Cut off the Ring terminals from the Green and Black **Field** wires and replace with Female Blade connectors.
- 4- Cut the **Small** 18AWG Red wire connected to the charge port. Leave this wire as long as possible from the wiring harness. Relocate the wiring harness toward the passenger side of the car.
- 5- Attach a 5/16 ring terminal to the red wire coming from the wiring harness that was cut in step 4 and attach it to B+ terminal of the contactor coming from the battery pack .
- 6- Replace the ATC 3A fuse located in the Black Rubber fuse holder with an ATC 10A fuse that is supplied.
- 7- Remove approximately two inches of tape from the wiring harness below the Black Rubber fuse holder and locate the Red/Yellow wire going to the white connector from the Contactor Coil and cut it. Leave as much of the wire as possible connected to the white connector. Tape up the end of the Red/Yellow wire left in the wiring harness. Locate the Red/White wire, also in the wiring harness, and splice the Red/Yellow coming from the White Contactor connector into it without cutting the Red/White wire. Tape the wiring harness back up to protect the wires.
- 8- Mount the controller with the bus bars facing the passenger side using two self tapping screws; one in the lower right hand (looking from top of controller) mounting hole and the other in the upper left side mounting hole.

- 9- Connect the two field wires; Green to F1 and Black to F2.
- 10- Connect the B+ cable from Output Side of the contactor and the Motor A2 cable to the controllers B+ bus bar.
- 11- Connect the Motor's A1 cable to the controller's M- bus bar.
- 12- Plug the G-19 adapter onto the controller and secure with the screw provided. Plug the cable harness plug into the G-19 adapter.
- 13- Replace the old battery cable from the Battery Pack Negative terminal to the controller's B- bus bar with the longer one supplied.
- 14- Replace the batteries and install the Fuse provided with the controller between the Battery Pack Positive terminal and the Cable going to the contactor Input.
- 15- Double check all your wiring. Position Tow/Run switch in the "Run" position.

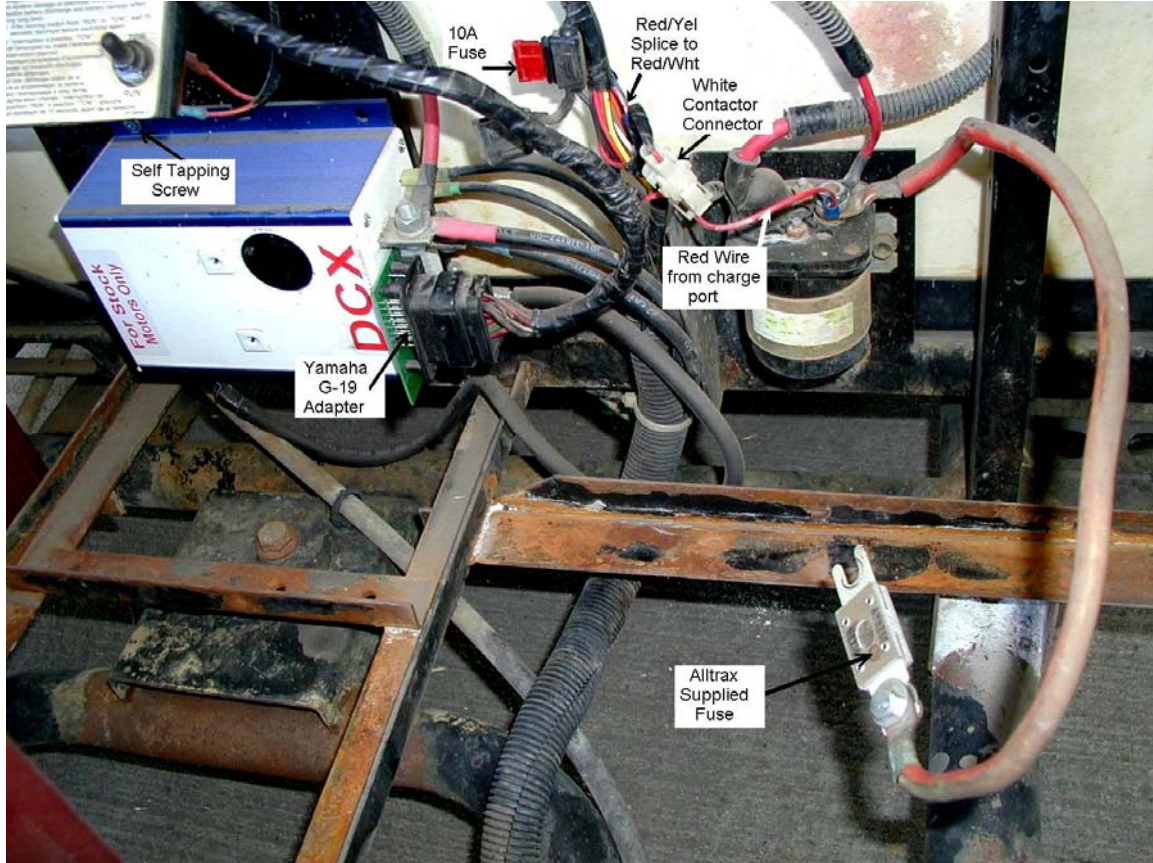

D&D Motor Systems, Inc.
215 Park Ave.
Syracuse, NY 13204
315-701-0635
10/27/05

Regen to YAMAHA G19

FOR SHUNT (SEP-EX) WOUND MOTORS

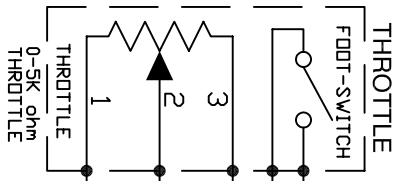
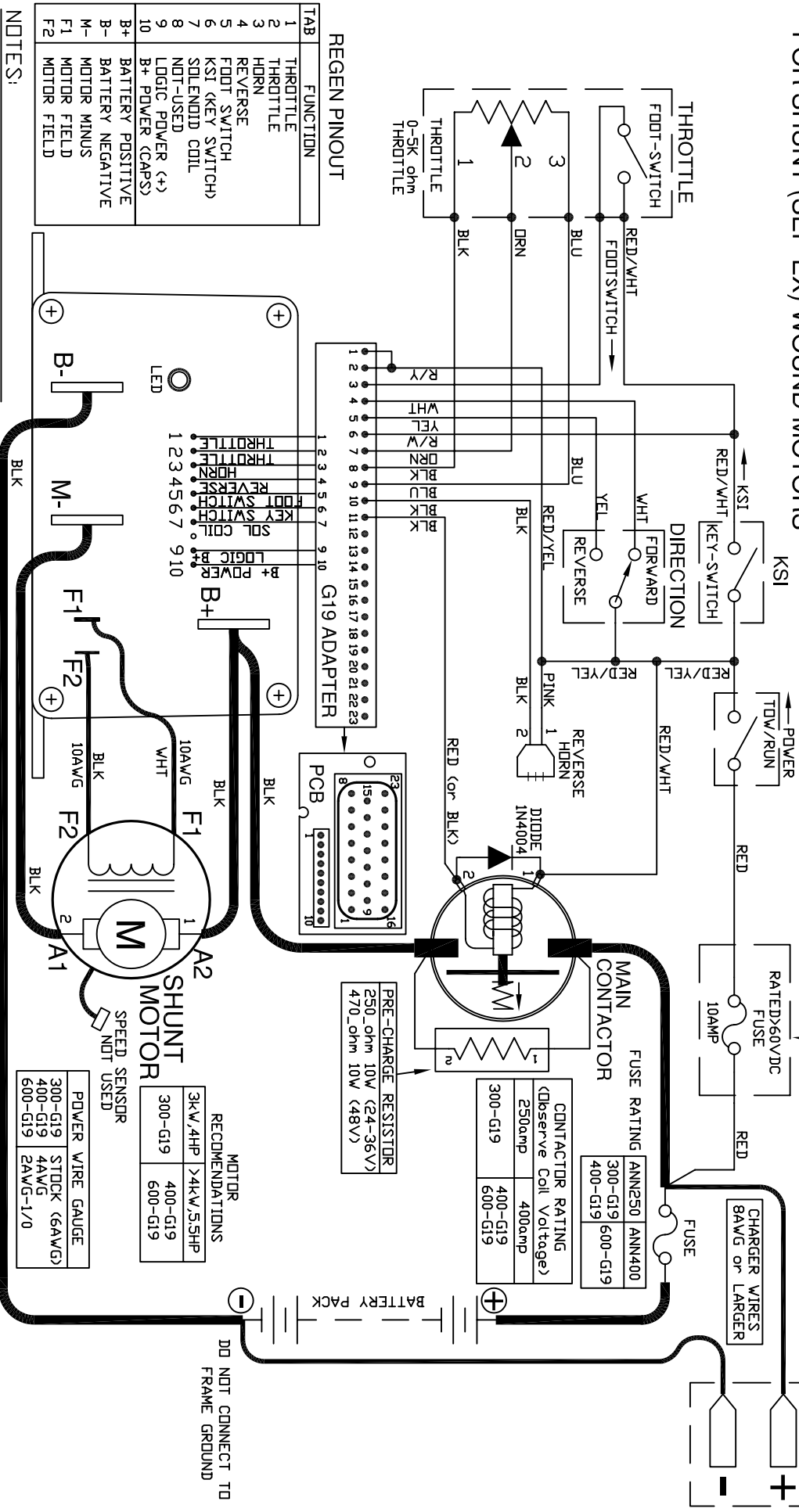

REGEN PINOUT

TAB	FUNCTION
1	THROTTLE
2	THROTTLE
3	HORN
4	REVERSE
5	FDOT SWITCH
6	KSI (KEY SWITCH)
7	SOLENOID COIL
8	NOT-USED
9	LOGIC POWER (+)
10	B+ POWER (CAPS)
B+	BATTERY POSITIVE
B-	BATTERY NEGATIVE
M-	MOTOR MINUS
F1	MOTOR FIELD
F2	MOTOR FIELD

NOTES:

- * FUSES REQUIRED FOR ALL INSTALLATIONS
- * DIODE REQUIRED ACROSS COILS / RELAYS
- * TDW/RUN SWITCH PREVENTS REGEN WHILE TDWING
- * ASSUMES FDOTSWITCH IS OPEN WHEN THROTTLE OFF
- > D&D RESERVES THE RIGHT TO CHANGE DOCUMENTATION WITHOUT NOTICE
- > D&D MAKES NO WARRANTY AS TO THE ACCURACY, SUFFICIENCY, OR SUITABILITY OF ANY TECHNICAL OR OTHER INFORMATION PROVIDED
- > SEE OPERATORS MANUAL FOR MORE INFORMATION

THIS FUSE MUST BE CHANGED FROM 3AMP TO 10AMP

RECOMMENDATIONS	MOTOR
3kW/4HP >4kW/5.5HP	400-G19
300-G19	400-G19
600-G19	600-G19

POWER WIRE GAUGE
300-G19 STDCK (6AWG)
400-G19 4AWG
600-G19 2AWG-1/0

PRE-CHARGE RESISTOR
250 ohm 10W (24-36V)
470 ohm 10W (48V)

CONTRACTOR RATING (Observer Coil Voltage)
250amp
400amp
600amp

FUSE RATING
ANN250
ANN400
300-G19
400-G19
600-G19

CHARGER WIRES 8AWG or LARGER
+
-

REVISIONS
REV. ECO. DATE APVD
A 010407 010407 TT

DWG SCALE: NTS
DRAWN T:Thorne 121406
ENGR D:Crockett 121406

TITLE
D&D Motor Systems, Inc.
Regen to Yamaha G19 w/Sep-Ex Wiring Dia

SIZE DOCUMENT NO.
A S Doc100-052

REV.
A

FILE:
_JMC-Regen-Yamaha-G19-wire-dia

SHEET
1 of 1

DO NOT SCALE DRAWING

215 Park Ave.
 Syracuse, NY 132031
 Phone:(315) 701-0555

PROPRIETARY
 THIS TECHNICAL DATA IS PROPRIETARY TO D&D MOTOR SYSTEMS, INC. REPRODUCTION, REUSE, OR DISCLOSURE IN WHOLE OR IN PART OF THIS DRAWING IS STRICTLY PROHIBITED.

D&D Motor Systems, Inc.

215 Park Ave.
Syracuse, NY 13204
Phone: 315-701-0635 Fax: 315-701-0859
email: sales@ddmotorsystems.com

VISIT OUR NEW
INTERACTIVE
WEBSITE TOOL !

www.ddmotorsystems.com

Choose Motor/Controller

Use our Motor/Controller
Selection Guide to locate a motor
based on your performance needs.

Performance Controllers for Shunt Wound DC Motors

- *Programmable
- *All MOSFET design
- *Throttles:
~0-5K ohms
~5K-0 ohms
~ITS



Sizes for 1204 & 1205 footprint

REGEN MODEL #	300	400	500	600
Battery Voltage	24-48V	24-48V	24-48V	24-48V
Current Limit	300A	400A	500A	600A
2 Minute Rating	300A	400A	500A	600A
5 Minute Rating	150A	210A	300A	350A
60 Minute Rating	135A	160A	250A	250A
Voltage Drop @100Amp	<0.30V	<0.10V	<0.09V	<0.08V

Features:

- Reverse does not require changeover relay
- 30 Amp Field Coil
- Configurations Available in DCS, PDS, PD+, G-19, IQ
- 2Amp Contactor Drive
- Reverse Horn Output

Performance Controllers for Series Wound + Perm-Mag DC Motors

- *Programmable
- *ALL MOSFET design
- *Throttles:
~0-5K ohms
~5K-0 ohms
~0-1K ohms
~ITS

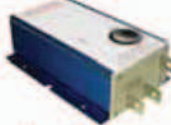

Sizes for 1204 & 1205 footprint

SERIES MODEL #	300	400	400L	500	650	300-72V	450-72V
Battery Voltage	24-48V	24-48V	24-48V	24-48V	24-48V	24-72V	24-72V
Current Limit	300A	400A	400A	500A	650A	300A	450A
2 Minute Rating	300A	400A	400A	500A	650A	300A	450A
5 Minute Rating	200A	300A	300A	350A	400A	200A	350A
60 Minute Rating	135A	150A	175A	250A	250A	125A	200A
Voltage Drop @100Amp	<0.30V	<0.13V	<0.18V	<0.09V	<0.08V	<0.16V	<0.11V

* Plug Brake versions available for most all models

To properly install your D&D controller

Battery / Motor Cable Sizes

Controller	Min wire AWG Standard Duty	Min Wire AWG Heavy Duty
300 Amp	OEM - 6 AWG	4 AWG
400 Amp	4 AWG	4 AWG
450 Amp	4 AWG	2 AWG
500 Amp	2 AWG	2 AWG
600 Amp	2 AWG	1/0 AWG
650 Amp	2 AWG	1/0 to 2/0 AWG

Resistor & Diode Mounting

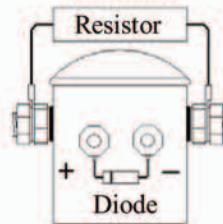

White Band(Positive)

Pre-Charge Resistor Values

Battery Pack Voltage	Resistor Value
12V-36V	250 Ohm 10W
48V	470 Ohm 10W
72V	1000 Ohm 10W

Protection Diodes across coils

Contactors Size	Diode	Diode Current
Stock OEM 70-100Amp	1N4004	1A
200A and up contactors	1N5408	3A

Forward/Reverse Switch Sizing

Controller Amperage	F/R Size
400A or less	Stock/HD
450A or more	Heavy Duty



Fuse Values ANN or ANL type



Controller Amperage	Fuse Rating
400A or less	250A
450A or more	400A

Contactors (Solenoids)

Standard Duty— Flat lands with speed and torque and slight or moderate performance expectations



Stock 70 AMP
Used with Stock
Controllers.
**DO NOT Use with
D&D Controller**



Stock 100 AMP
Use with Stock
Controllers 300
AMPS and below
[Stock F&R Switch]

Heavy Duty— Maximum performance, high speed, maximum torque, pulling loads, hilly terrain or hunting buggies.



Performance 200 AMP
Use with 300 and 400
AMP Controllers
[HD F&R Switch]



Heavy Duty 400 AMP
Use with 500 and 600
AMP Controllers
[HD F&R Switch]

Note: Incorrect contactor can cause controller failure.